



セルフリジェネレイティブバーナーは、蓄熱室を備えることにより廃熱回収率を向上させ、大幅な省エネルギーを実現させたため、CO₂の低減、廃ガス再循環により低NO_xを実現させた地球環境にやさしい画期的なバーナーです。

さらに、従来の蓄熱式燃焼装置は、2台のバーナーを備えるため高価になりましたが、このバーナーは、蓄熱式燃焼を1台で可能にした安価なリジェネレイティブバーナーです。

Self-regenerative burner is earth-friendly and epoch-making in that it can save energy and reduce CO₂ by greatly increasing waste heat recovery efficiency and can also reduce NO_x by recirculating waste gas. Conventional 2-burner system is very expensive, while the self-regenerative burner is economical. By including more than one regenerator and selector valve in the burner body, the self-regenerative burner can perform regenerative combustion only with one burner. Moreover, owing to simple piping and other accompanying work, the self-regenerative burner can substantially cut the initial cost.

- 燃 料 Fuel : 各種燃料ガス Fuel Gases
- 基 準 圧 Standard Pressure : Gas 10kPa ・ Air 6kPa
- 炎監視方式 Flame Safeguard System : 紫外線光電管方式 UV Phototube
- 付 属 品 Accessories : 切替弁 Selector valve

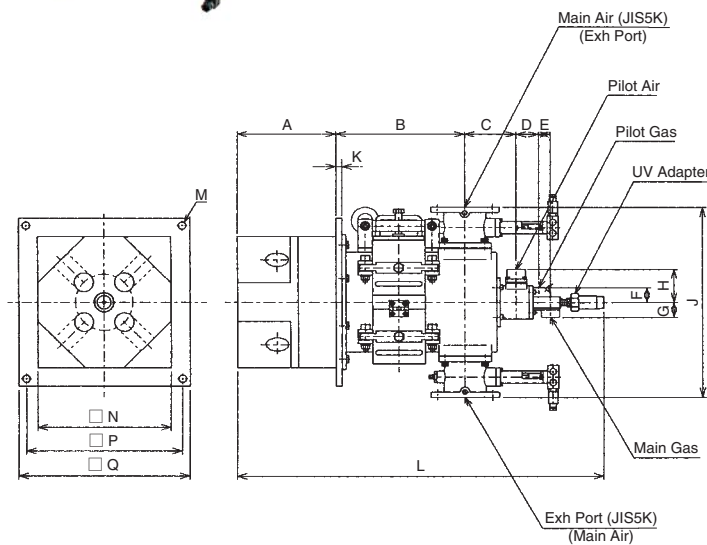

寸 法 / DIMENSION

型式 Type	※燃焼容量 Cap. kW(×10 ³ kcal/h)	接続口径 Connection					A	B	C	D	E	F	G	H	J	K	L	M	N	P	Q	質量 Mass (kg)
		Pilot Air (Rc)	Pilot Gas (Rc)	Main Air (JIS5K)	Main Gas (Rc)	Exh. (JIS5K)																
SRB-7	70 (6)	1	3/8	80 A	1	80 A	250	261	134	30	40	40	89	452	16	873	6-φ20	350×270	410×330	450×370	160	
SRB-15	150 (13)			80 A		80 A	260	339	134					510		962		4-φ20	350	410	450	210
SRB-25	250 (22)			100 A	1 1/2	100 A	300	400	139	59	45	49	46	104	600	1309	1095	8-φ20	400	470	500	330
SRB-40	400 (34)			125 A		125 A	350	447	155	700					1207		500		560	600	500	
SRB-60	600 (52)			150 A		150 A	384	497	173	852					1309		610		680	730	750	
SRB-100	1000 (86)	1/2	200 A	2 1/2	200 A	450	586	201	68	51	65	62	125	1120	22	1520	16-φ24	810	880	940	1500	

※炉温 1300 度が基準。 ※ The above capacity based on a furnace temperature of 1300°C.

フローシート / FLOW SHEET

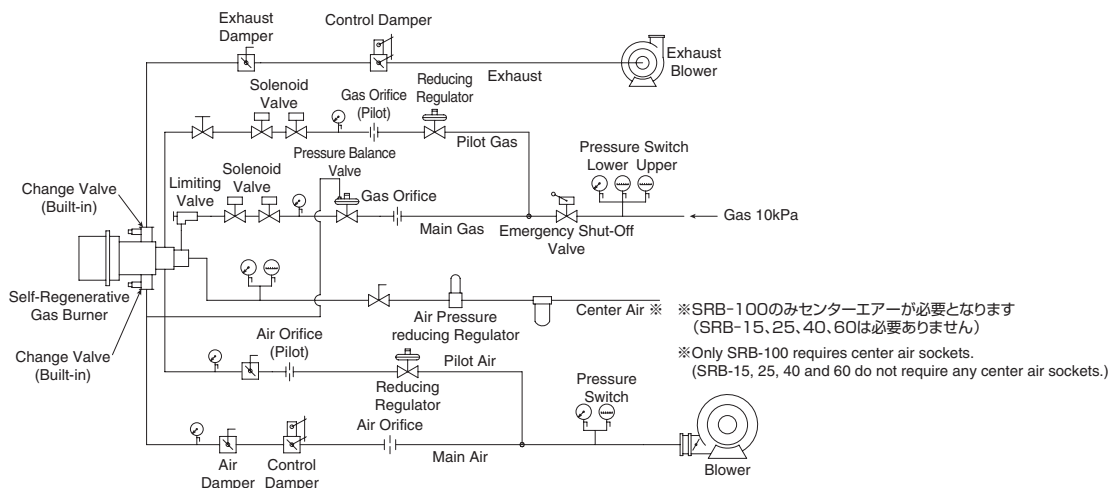

※SRB-100のみセンターエアが必要となります (SRB-15、25、40、60は必要ありません)

※Only SRB-100 requires center air sockets. (SRB-15, 25, 40 and 60 do not require any center air sockets.)

バーナー流量・質量表 / SPECIFICATION

型式 Type	燃焼容量 Main Burner Cap. kW (x10 ³ kcal/h)	燃焼空気流量 Main Air Flow Rate (m ³ /h (nor.))	排気流量 Exh.Flow Rate (m ³ /h (nor.))	パイロット空気流量 Pilot Air Flow Rate (m ³ /h (nor.))	パイロット燃焼容量 Pilot Burner Cap. kW (x10 ³ kcal/h)	ボール質量 Ceramics Ball Mass (kg)	ボールサイズ Ceramics Ball Size (inch)	センターエア流量 Center Air Flow Rate (m ³ /h (nor.))
SRB-7	70 (6)	125	170	7.2	7 (6.0)	12	3/8	—
SRB-15	150 (13)	270	360	9.5	9 (7.8)	20	3/8	—
SRB-25	250 (22)	450	600	15.0	14 (12.0)	40	1/2	—
SRB-40	400 (34)	720	960	15.0	14 (12.0)	60	3/4	—
SRB-60	600 (52)	1080	1440	17.0	16 (14.0)	120	3/4	—
SRB-100	1000 (86)	1800	2400	24.0	23 (20.0)	200	3/4	3.5

技術資料 / TECHNICAL DATA

炉温に対するNOx特性
NOx for Furnace Temp.

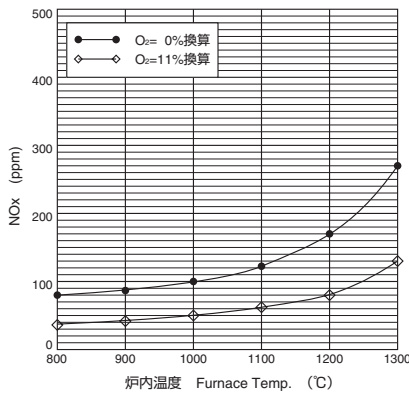

燃料節約率
Fuel Save Ratio

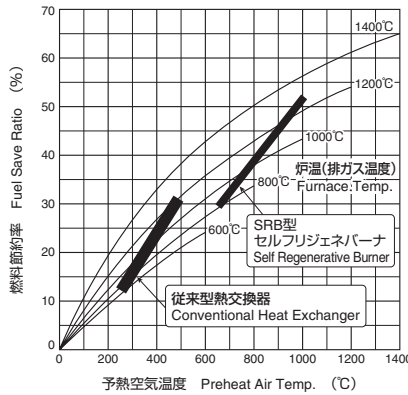

排ガス温度と燃料節約率
Exhaust Temp. and Fuel Save Ratio

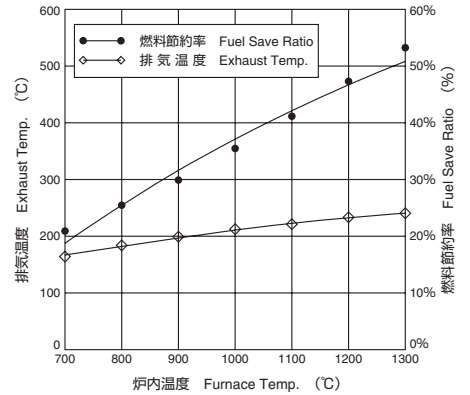

● 運転条件 Condition

バーナー Burner	SRB-15
燃焼容量 Capacity	150kW
燃料 Fuel	13A
残 O ₂ Remained O ₂	2 ~ 4%

● 運転条件 Condition

バーナー Burner	SRB-60
燃焼容量 Capacity	600kW
燃料 Fuel	LPG

温度と排ガス
Temp. and Exhaust

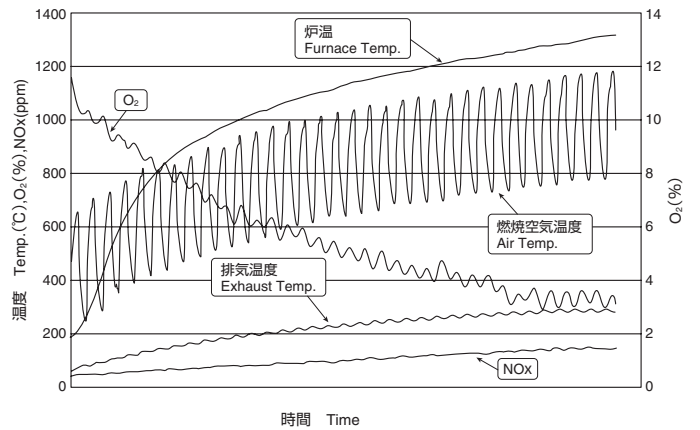

フレイムパターン / FLAME PATTERN

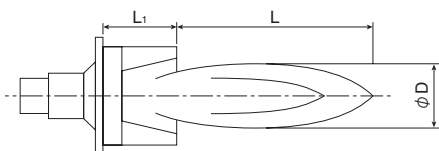

● 運転条件 Condition

燃焼空気圧力 Air Pressure	6kPa
燃料 Fuel	LPG
炉圧 Furnace Pressure	+20 ~ 30Pa

Type	φ D	L	L ₁
SRB-7	200	1000	250
SRB-15	230	1300	260
SRB-25	300	1900	300
SRB-40	350	2400	350
SRB-60	600	2800	384
SRB-100	700	3000	450

■ ご注文の際は、弊社営業部までご連絡ください。 ■ If you order, please contact our sales department for instructions.